



369

MOTOR PROTECTION SYSTEM

Integrated protection and control for medium sized AC motors

KEY BENEFITS

- Enhanced Thermal Model including RTD and Current Unbalance Biasing
- Complete Asset monitoring with programmable RTD inputs for Stator, Bearing and Ambient temperature protection
- Enhanced reporting - Motor Health Reports provide critical information for preventative maintenance
- Reduce troubleshooting time and maintenance costs -Event reports, waveform capture, motor start data logger
- Multiple communication protocols - Modbus RTU, Profibus, DeviceNet, Modbus TCP/IP
- Simplified programming with the EnerVista™ 369 Motor Settings Auto-Configurator
- Optional Conformal coating for exposure to chemically corrosive or humid environments (option)

- Field upgradable settings and firmware
- Suitable for hazardous locations - UL certification for Class 1 Division 2 applications (option MOD502)
- Installation flexibility - Remote display and remote RTD options
- Safe and reliable motor re-start on “Down Hole” pump applications - Unique back spin detection feature detects flow reversal on a pump motor, enabling timely and safe motor restarting
- User definable parameters and data size for DeviceNet polling
- User definable parameters and data size for Profibus DPV1 cyclic data
- Motor learned data on historical start characteristics

APPLICATIONS

- Protection and control for medium sized AC motors
- “Down Hole” pump applications
- Suitable for applications involving Variable Frequency Drives
- Two Speed motor application

FEATURES

Protection and Control

- Enhanced thermal model
- Stall / Jam protection
- Undervoltage, overvoltage
- Underfrequency
- Thermal overload
- Undercurrent/current unbalance
- Variable lockout time
- Overtemperature 12 RTDs (R option)
- Starts/hour, time between starts
- Voltage Phase Reversal (M option)
- Current based phase reversal
- Undervoltage Auto-restart

User Interface

- 40 Character LCD Display
- 10 System and Motor Status LED's
- Keypad for configuration and viewing metered values
- 4 programmable analog outputs
- 369 Motor Settings Auto-Configurator

Monitoring and Metering

- Metering - current, voltage, power, energy, frequency, RTD Temperature, Remote RTD
- Fault diagnosis, - Event Record, Oscillography, Motor Starting Data Logger
- Motor Health Report
- Statistical information & learned motor data
- Voltage/frequency/power display (M option)
- 4 analog outputs (M option)

Communications

- Front Panel RS232 port for programming and troubleshooting
- Optional embedded Ethernet port
- Optional Profibus DP/DPV1 or DeviceNet via dedicated port
- Multiple Protocols - Modbus RTU, Modbus TCP/IP

EnerVista™ Software

- State of the art software for configuration and commissioning GE Multilin products
- Document and software archiving toolset to ensure reference material and device utilities are up-to-date
- EnerVista™ Integrator providing easy integration of data in the 369 into new or existing monitoring and control systems



Motor Protection

Protection & Control

The 369 is a digital motor protection system designed to protect and manage medium sized AC motors and their driven equipment. It contains a full range of selectively enabled, self contained protection and control elements as detailed in the Functional Block Diagram and Features table.

Motor Thermal Model

The primary protective function of the 369 is the thermal model with six key elements:

- Overload Curves
- Unbalance Biasing
- Hot/Cold Safe Stall Ratio
- Motor Cooling Time Constants
- Start Inhibit and Emergency Restart
- RTD Biasing

Overload Curves

The curves can take one of two formats: standard or custom. For all curve styles, the 369 retains thermal memory in a thermal capacity used register which is updated every 0.1 second. The overload pickup

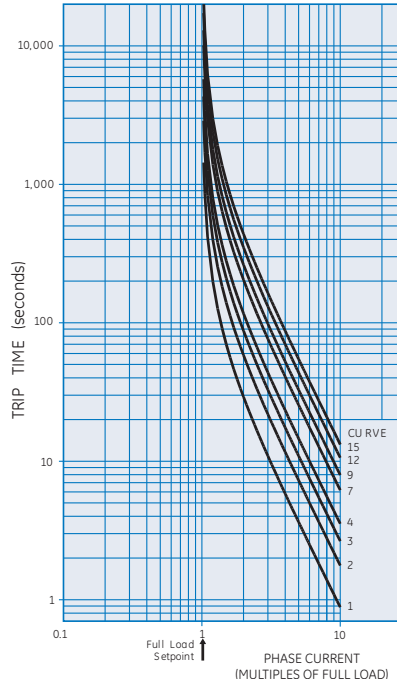

Fifteen standard overload curves

determines where the running overload curve begins.

The 369 standard overload curves are of standard shape with a multiplier value of 1 to 15.

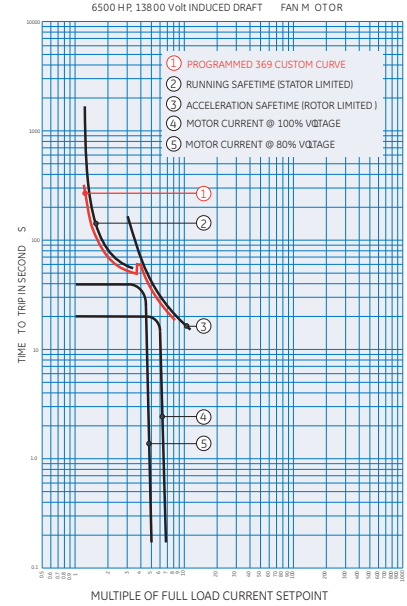

Typical FlexCurve™

FlexCurves™

A smooth custom overload curve is created using FlexCurves™. These curves can be used to protect motors with different rotor damage and stator damage curves, allowing total motor design capacity with complete protection.

Functional Block Diagram

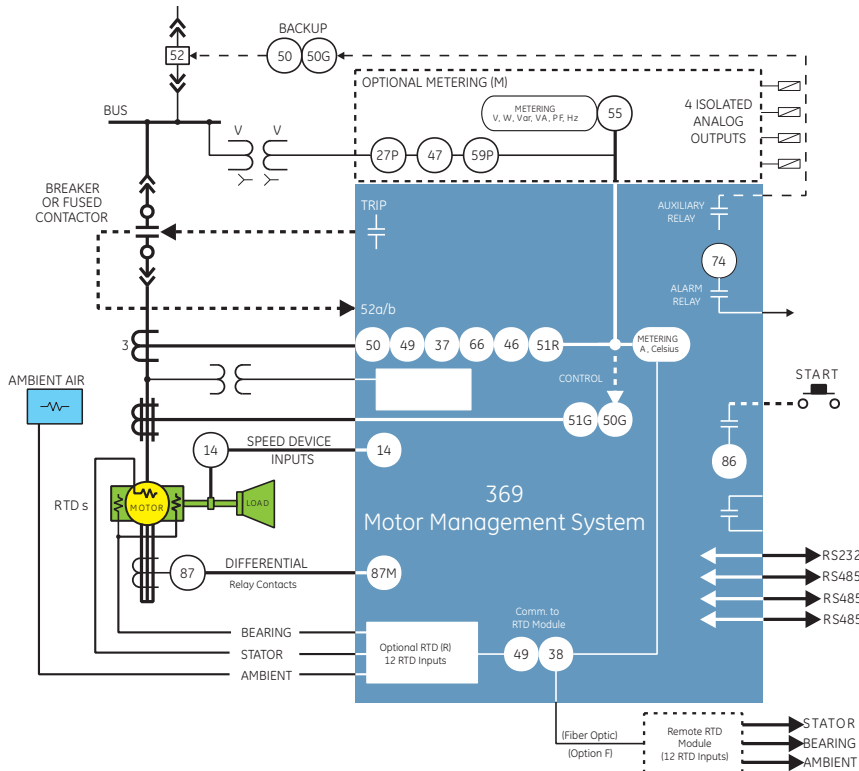

ANSI Device Numbers & Functions

Device Number	Function
14	Speed Switch
27P/59P	Undervoltage/Overvoltage
37	Undercurrent/Underpower
38	Bearing RTD
46	Current Unbalance
47	Phase Reversal
49	Stator RTD
50	Short Circuit and Short Circuit Backup
50G/51G	Ground Overcurrent and Ground Overcurrent backup
49	Overload
51R	Mechanical Jam
55	Power Factor
66	Starts/Hour & Time Between Starts
810/U	Frequency
86	Overload Lockout
87M	Differential

Unbalance (Negative Sequence Current) Biasing

Negative sequence current, which causes rotor heating, is not accounted for in the thermal limit curves supplied by the motor manufacturer. The 369 relay can be programmed to calculate the negative sequence current, and bias the thermal model to reflect the additional heating.

RTD Biasing (Relay Option R)

The thermal overload curves are based solely on measured current, assuming a normal 40°C ambient and normal motor cooling. If the motor cooling systems fail, or if the ambient temperature is unusually high, standard overload protection will not detect the increase in temperature.

When ordered with the RTD option, the 369 can monitor the actual motor temperature, and calculate the Thermal Capacity Used (TCU) based on the RTD Bias curve. This TCU value will then be compared with the TCU determined by the overload curve. The higher of the two values will be used. For RTD temperatures below the RTD BIAS MINIMUM setting, no biasing occurs. For maximum stator RTD temperatures above the RTD BIAS MAXIMUM setting, the thermal memory is fully biased and forced to 100%.

Cool Time Constants

The 369 has a true exponential cooldown characteristic which mimics actual motor cooling rates, provided that motor cooling time constants are available for both the stopped and running cases. When ordered with the RTD option, the stopped and running cool time constants will be calculated by the 369 based on the cooling rate of the hottest stator RTD, the hot/cold stall ratio, the ambient temperature (40 °C if no ambient RTD), the measured motor load and the programmed service factor or overload pickup.

Start Inhibit

The Start Inhibit function prevents starting of a motor when insufficient thermal capacity is available or a motor start supervision function dictates the start inhibit.

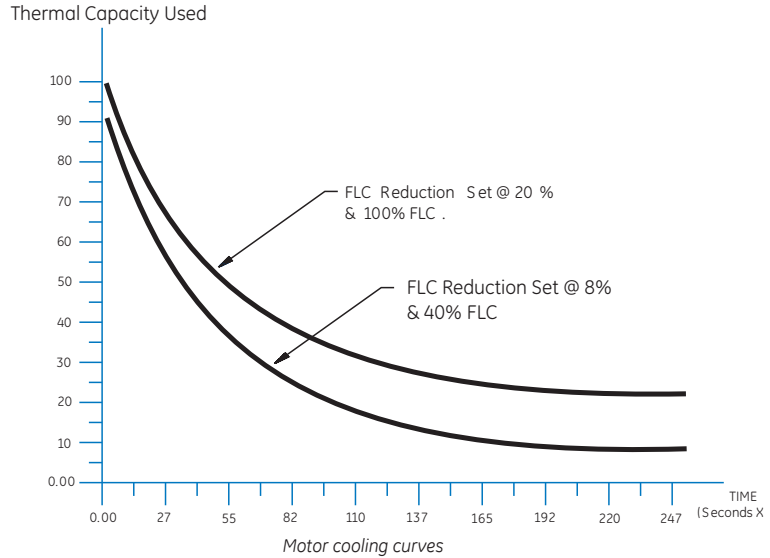

Undercurrent (Minimum Load)

The undercurrent function is used to detect a decrease in motor current caused by a decrease in motor load. This is especially useful for indication of conditions such as loss of suction for pumps, loss of airflow for fans, or a broken belt for conveyors. A separate undercurrent alarm level may be set to provide early warning.

Ground Overcurrent

For zero sequence ground overcurrent protection, all three of the motor conductors must pass through a separate ground CT. CTs may be selected to detect either high-impedance zero sequence

ground or residual ground currents. The ground fault trip can be instantaneous or time delayed by up to 255 seconds. A low level of ground fault pickup is desirable to protect as much of the stator winding as possible. A 50:0.025 A CT, 1 A or 5 A CT may be used for ground fault detection.

Rapid Trip/Mechanical Jam

During Overload conditions, quick motor shut down can reduce damage to gears, bearings, and other mechanical parts associated with the drive combination. The Mechanical Jam protection will operate for currents above a user-programmable pickup level.

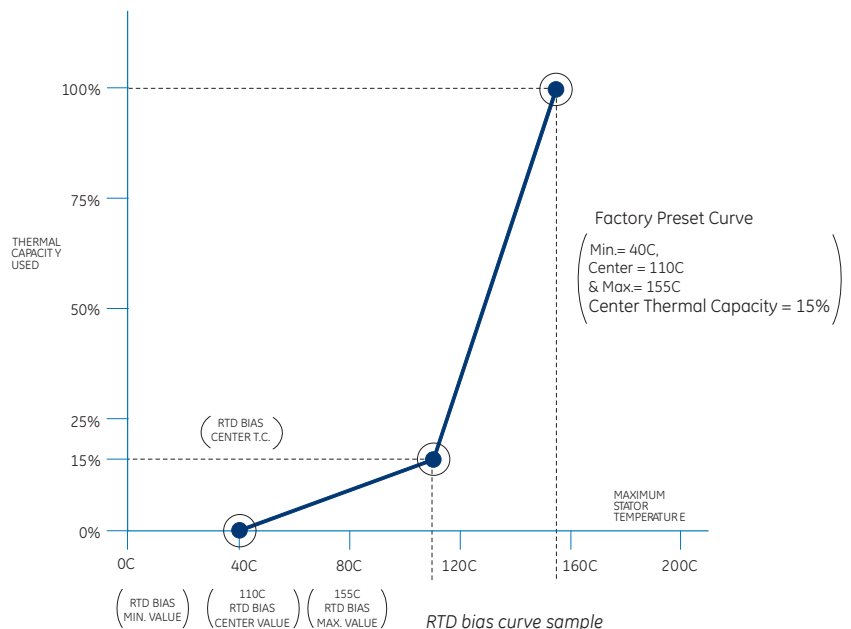

RTD Protection (Relay Option R)

The 369 R option provides a total of 12 programmable RTD inputs that are used for monitoring the Stator, Bearing and ambient temperatures. Each RTD input has 3 operational levels: alarm, high alarm and trip. The 369 supports RTD trip voting and provides open and short RTD failure alarms. Alternatively, a remote RTD module (RRTD) can also be used with the 369 for temperature monitoring.

Back-Spin Detection (Option B)

The Back-Spin Detection option is used to detect flow reversal of a pump motor when check valves are not functioning or are non-existent. Once the pump has stopped rotating, the Back-Spin Detection option will allow the pump to safely restart, minimizing downtime and preventing motor damage.

The Back-Spin Detection option uses sensitive circuits to detect the voltage produced by the back-spinning motor. Digital signal processing techniques determine the direction of rotation and predict the pump stop time. The metering option (M) is included in the Back-Spin Detection option (B) option.

VFD Applications

The 369 is capable of protecting motors fed from variable frequency drives (VFDs), including pulse width modulated (PWM) drives. The 369 has been extensively tested with varying current waveforms and frequencies ranging from 20 to 100Hz.

Two Speed Motor Applications

The 369 is capable of protecting two speed motors. The 369 has dual overload curves for two speed motor application so that each speed is adequately protected.

Undervoltage Auto-restart

This feature can be used to restart a motor after an undervoltage trip caused by a momentary power loss. When enabled, the 369 will issue a re-start command to the motor. If the system power is restored to above the Pickup / Restoration setting. This element includes two independent sets of power loss and restart delay timers to allow customization of the scheme.

Inputs and Outputs

The 369 features a variety of digital input and output channels. Any of the programmable digital inputs may be selected and programmed as a separate General Switch, Digital Counter, or Waveform Capture Input. In addition the programmable digital inputs may be selected and programmed to perform one of the following functions: Emergency Restart, Differential Switch, Speed Switch, or Remote Reset as described below.

Setpoint Access

These terminals must be shorted together in order to store new setpoints using the relay keypad.

Emergency Restart

It may be necessary to restart a faulted motor for reasons of production or safety. To override a start inhibit or overload trip lockout condition, the emergency restart feature can be used. This clears the thermal memory, allowing a manual reset and restart. The 369 can also be programmed to provide a single shot emergency restart following an overload trip. The accumulated thermal capacity used value is automatically reduced to a level that will allow a restart. After the restart attempt, if the relay trips the motor again on running overload, it will remain latched for the appropriate lock-out time.

Speed Switch Input

The speed switch input terminals allow use of an external speed device. This is typically used to allow a locked rotor condition to be distinguished from a normal start, and to shut down following a short delay.

Differential Relay Input

The differential input accepts contact closure from an external differential relay to trip the protected motor via the 369.

Spare Input

The spare input terminals can be configured to represent either a standard or a specific contact input. The Spare input is generally used as the starter status contact. The 52b contact from a circuit breaker gives positive identification of the

position of the breaker (open or closed), and should be used with any synchronous machine, or induction motor that may run unloaded.

Remote Reset

This input can be used for remote or automatic reset from a control switch, a PLC, or a DCS output.

Outputs

The 369 has four output relay contacts. The trip relay acts as the main latched output relay. An alarm and two auxiliary output relays are also provided. The Alarm and Auxiliary 1 relays may be programmed for latched or unlatched modes. All relays may be programmed fail-safe or non fail-safe.

Analog Outputs (Option M)

Three optional isolated analog outputs are provided (in addition to the single analog output available in the base model). Use the configurable analog outputs to provide standard transducer signals to local monitoring equipment. They can be field selected as 0 to 1, 0 to 20 or 4 to 20 mA outputs. The analog outputs can be configured to provide suitable outputs based on any measured analog value, or any calculated quantity.

Monitoring and Metering

The 369 offers a choice of optional monitoring and metering functions including:

Actual Values

Actual values can be viewed for:

- Average and individual phase currents
- RTD temperatures (hottest, individual, maximum) (R Option)
- Current Unbalance
- Ground leakage current
- Thermal capacity remaining / estimated time to trip at present overload level
- Motor load as a percent of full load
- Phase-to-phase or phase-to-neutral voltage (M option)
- W, var, MWhr, PF, Hz (M option)

Metering (Option M)

The 369 metering option provides monitoring of quantities such as PF, kW, and frequency. Several protection functions can be performed based on these parameters, including:

- Voltage
- Watts (kW, MW)
- Vars (kVar, MVar)
- Power factor
- Frequency
- Energy (MWh)

Pre-Trip Alarms

The 369 can trigger an alarm prior to a trip caused by the following conditions:

- Immediate overload/stall warning
- Ground fault
- Mechanical jam
- Unbalance
- Undercurrent
- RTD overtemperature, broken RTD sensor, low temperature RTD
- Internal Self-test
- Under/overvoltage (M option)
- Low power factor (M option)

Event Recorder

After a trip, the cause of the trip, measured current values, unbalance, and temperature present at the time of trip are displayed. If the M or B options have been ordered, information will also include voltages, power, and frequency. This information helps facilitate troubleshooting. An event record of the last 512 events helps identify persistent problems.

Oscillography

The 369 will record up to three waveform records, each capturing 16 cycles of data. The oscillography will be triggered when a trip is issued by the 369 relay. Information captured includes phase and ground currents, phase voltages (M option) and the status of contact inputs and outputs. Each record will be time and date stamped, and will include the cause of trip.

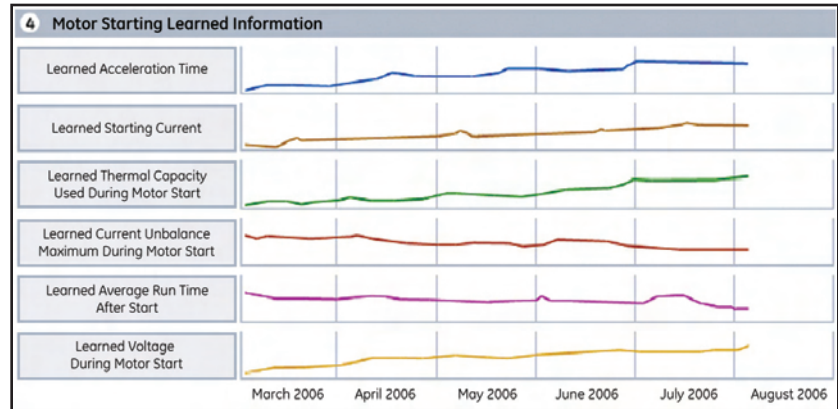

Track changes in motor starting characteristics, identifying potential failures before they become critical

Statistical Data

The 369 records the following statistical data:

- Total running hours
- Number of motor starts
- Total number of motor trips
- Breakdown of types of motor trips
- Total accumulated mega-watt hours (with the M option)

This information can help diagnose common motor faults, as well as assist in planning preventative maintenance.

Learned Information

The 369 learns the starting characteristics of the motor, providing information that will assist with troubleshooting faults that

occur during starting, as well as planning preventative maintenance.

- Acceleration time
- Starting Current
- Thermal capacity used during start
- Cool time Constants
- Unbalance K factor
- Average Motor Load

Motor Start Data Logger

In addition to the learned information captured for every start, the Motor Start Data Logger will record up to 30 seconds of digital and analog waveforms during motor starts. Captured information includes:



Troubleshoot faults that occur during motor starts using the Motor Start Data logger.

- Average Phase Current
- Current Unbalance
- Ground Current
- Average Voltages
- Thermal Capacity Used
- System Frequency
- Breaker Status contact

Testing

A simulation mode allows forcing relay contacts and analog outputs without the need for a relay test set. This is an ideal tool during commissioning for system functional testing.

User Interfaces

Display and Keypad

The 40-character display and keypad provide convenient local communications and control. Setpoints can be adjusted using the keypad and display. To help prevent unintentional setting changes, a setpoint access input must be shorted before changes can be made. The display module can be separated from the relay and mounted remotely.

LED Indicators

Ten LED indicators on the front panel provide quick visual indication of the motor status.

Remote Display

The 369 can be installed with the display mounted remotely, reducing the required mounting space within the panel.

Communications

A front RS232 port is provided for downloading setpoints and interrogating the relay using the EnerVista™ 369.

Three independent rear RS485 ports offer the customer flexibility and performance for their communication network. The 369 can communicate at baud rates up to 19,200 bps using the industry standard Modbus® RTU protocol. Fiber optic (option F) Profibus interface (option P), DeviceNet (option D), and Ethernet (option E) ports are also available. The optional direct connect RJ45 Ethernet port can be used to connect the 369 to 10 Mbps Ethernet networks. The communication system of the 369 is designed to allow simultaneous communication via all ports.

Using Ethernet as the physical media to

integrate the 369 to Local or Wide Area Networks replaces a multidrop-wired network (e.g., serial Modbus®), and eliminates expensive leased or dial-up connections, reducing operating costs.

EnerVista™ Software

The EnerVista™ Suite is an industry leading set of software programs that will simplify every aspect of using the 369 relay. Tools to monitor the status of the motor, maintain the relay, and integrate information measured by the 369 into HMI or SCADA monitoring systems are available. Also provided are the utilities to analyze the cause of faults and system disturbances using the powerful waveform and Sequence of Event viewers that come with the EnerVista™ 369 Setup Software that is included with each relay.

EnerVista™ Launchpad

EnerVista™ Launchpad is a powerful software package that provides users with all of the setup and support tools needed for configuring and maintaining GE Multilin products. Launchpad allows configuring devices in real-time by communicating using serial, Ethernet, or

Power System Troubleshooting

The 369 contains many tools and reports that simplify and reduce the amount of time required for troubleshooting power system events.

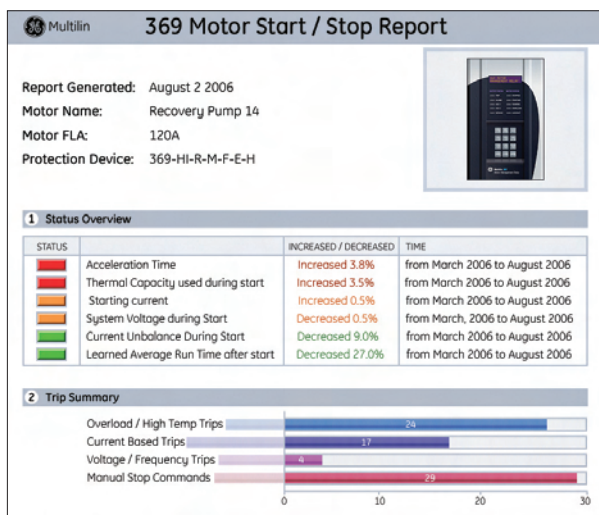

The Motor Health Report allows you to easily “see” how your motor is doing:

- Start/stop history
- Comprehensive trip details
- Learned acceleration time and starting current
- Many other motor health details

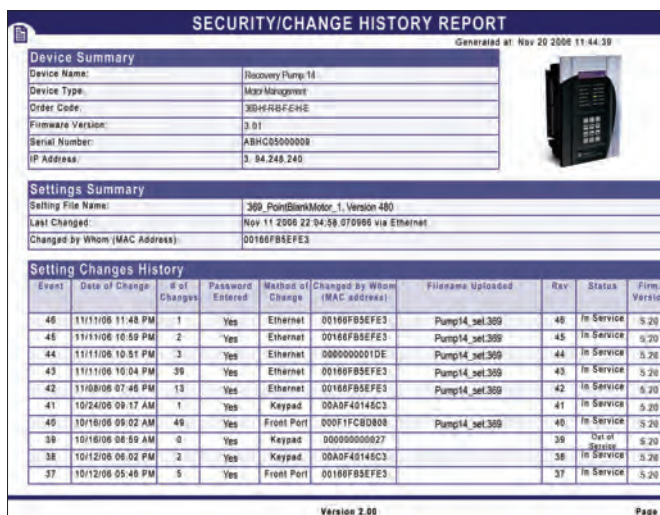

Track changes to settings in the 369 with the built-in setting security audit trail report

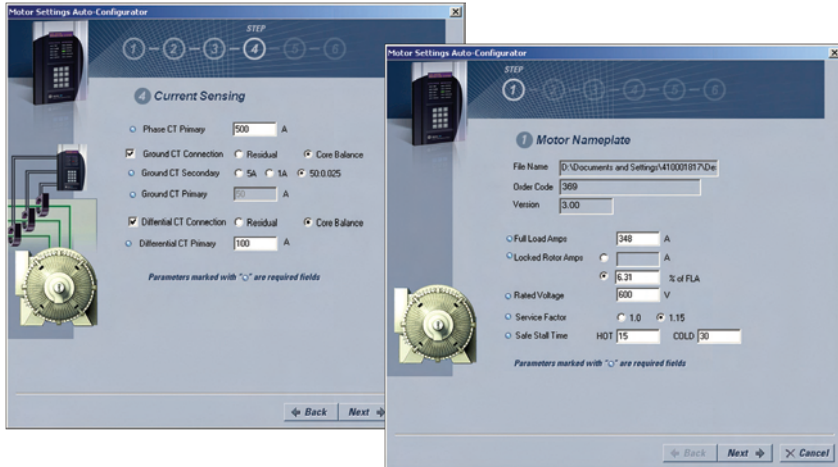

Create complete settings files for your 369 in 6 simple steps using the Motor Settings Auto-Configurator.

modem connections, or offline by creating setting files to be sent to devices at a later time. Included in Launchpad is a document archiving and management system that ensures critical documentation is up-to-date and available when needed. Documents made available include:

- Manuals
- Application Notes
- Guideform Specifications
- Brochures

- Wiring Diagrams
- FAQs
- Service Bulletins

Motor Settings Auto-Configurator

Included with every 369 relay is the Motor Settings Auto-Configurator. This configurator will generate a complete 369 settings file based on motor nameplate and system information entered by the user. Once all information is entered, the auto-configurator will generate the settings

file, as well as provide documentation indicating which settings were enabled, along with an explanation of the specific parameters entered.

Motor Health Report

This reporting function is included with every 369 relay, providing critical information on the historical operating characteristics of your motor during motor starting and stopping operations. Included in the report are:

- Motor operation historical timeline, displaying start, emergency restart, stop, trip, and alarm operations.
- Historical record of motor trips
- Extensive trending of motor learned information (trending information up to a maximum of 1250 motor start operations)
- High Speed motor start data logger trends, including current, current unbalance, voltage, frequency, TCU and breaker contact status during start

Viewpoint Maintenance

Viewpoint Maintenance provides tools that will increase the security of your 369, create reports on the operating status of the relay, and simplify the steps to troubleshoot protected motors.

Tools available in Viewpoint Maintenance include:

- Settings Audit Trail Report
- Device Health Report
- Comprehensive Fault Diagnostics

EnerVista™ Integrator

EnerVista™ Integrator is a toolkit that allows seamless integration of GE Multilin devices into new or existing automation systems.

Included in EnerVista Integrator is:

- OPC/DDE Server
- GE Multilin Drivers
- Automatic Event Retrieval
- Automatic Waveform Retrieval

Front Panel

Display

40 Character LCD display for viewing actual values and programming setpoints

Rugged, corrosion and flame retardant case

Status Indicators

4 LEDs indicate when an output is activated.

Motor Status Indicators

LEDs indicate if motor Stopped, Starting, Running, Overloaded, or Locked out due to an active Start Inhibit element.

Keypad

Used to display actual values, causes of alarms, causes of trips, fault diagnosis information, and to program setpoints

Computer Interface

RS232 comm port for connecting to a PC. Use for downloading setpoints, monitoring, data collection & printing reports



Technical Specifications

PROTECTION

OVERLOAD CURVES TRIP TIME

Curves: 15 curves, fixed shape/program. FlexCurve™
Overload pickup: 1.0 – 1.25 x FLA
Accuracy :Pickup: ±1% of full scale
Time: ±100 ms or ±2% of total trip time

SHORT CIRCUIT AND GROUND TRIP

Ground trip level: 0.25 – 25.00 A (50:0.025 CT)
 10 – 100% (1 A/5 A CT)
S/C trip level: 2 – 20 x CT, OFF

Intentional delay: INST. or 10 ms to 2000 ms (S/C) (GROUND)
 45 ms

START PROTECTION

Thermal: Separate start and run protection
Activation: Inrush current increases 5% to >101% FLC in 1 sec
Deactivation: Current drops <Overload Pickup Level motor running if current >5% FLC

Locked rotor: 2 – 10 x FLC
Stall time: 1.0 – 600.0 sec

THERMAL MODELING

Thermal capacity: Separate stop/run, exponential cool down
Cool rate: Stop: cool time constant 1 – 500 min
 Run: cool time constant 1 – 500 min
Hot/cold: 50 – 100%, hot after 15 min running
Lockout: 1 – 500 min programmable
 ±20% power on or off

UNBALANCE

Range: 4 – 30%
Accuracy: ±2%
Delay: 0 – 255 sec

Calculation: $I_{av} > I_{FLC} \quad UB\% = \frac{I_m - I_{av}}{I_{av}} \times 100\%$

$I_{av} < I_{FLC} \quad UB\% = \frac{I_m - I_{av}}{I_{FLC}} \times 100\%$

where: I_{av} = average phase current
 I_m = phase with maximum deviation from I_{av}
 I_{FLC} = motor full load current setting

METERING

PHASE CURRENT INPUTS

Conversion: True rms, sample time 1.04 ms
CT input: 1 A and 5 A secondary
Range: 0.05 to 20 x phase CT primary amps
Full scale: 20 x phase CT primary amps
Frequency: 20 – 300 Hz
Accuracy: @ <2 x CT 0.5% of 2 x CT
 @ > 2 x CT 1.0% of 20 x CT

GROUND CURRENT INPUT (GF CT)

CT input (rated): 1 A / 5 A secondary and 500:0.025
CT primary: 1 – 5000 A (1 A / 5 A)
Range: 0.1 to 1.0 x CT primary (1 A / 5 A)
 0.05 to 16.0 A (50:0.025)

Full scale: 1.0 x CT primary (1 A / 5 A)
Frequency: 20 – 100 Hz
Conversion: True rms 1.04 ms / sample
Accuracy: ±1% of full scale (1 A / 5 A)
 ±0.07 A @ 1 A (50:0.025)
 ±0.20 A @ 16 A (50:0.025)

PHASE/LINE VOLTAGE INPUT(VT)(OPTION M)

VT ratio: 1.00 – 240:1 in steps of 0.01
VT secondary: 240 VAC (full scale)
Range: 0.05 – 1.00 x full scale
Frequency: 20 – 100 Hz
Conversion: True rms 1.04 ms/sample
Accuracy: ±1.0% of full scale
Burden: >200 kΩ
Max continuous: 280 VAC

ACCURACY			
PARAMETER	(FULL SCALE)	RESOLUTION	RANGE
kW	±2%	1 kW	±32,000
kvar	±2%	1 kvar	±32,000
kVA	±2%	1 kVA	0 – 50,000
mWh	±2%	1 MWh	0 – 65,535
±kvarh	±2%	1 kvarh	0 – 65,535
Power Factor	±1%	0.01	±0.00 – 1.00
Frequency	±0.02 Hz	0.01 Hz	20.00 – 100.00
kW Demand	±2%	1 kW	0 – 50,000
kvar Demand	±2%	1 kvar	0 – 50,000
kVA Demand	±2%	1 kVA	0 – 50,000
Amp Demand	±2%	1 A	0 – 65,535

MONITORING

WAVEFORM CAPTURE

Length: 3 buffers containing 16 cycles of all current and voltage channels
Trigger position: 1 – 100% pre-trip to post-trip
Trigger: trip, manually via communications or digital input

INPUTS

RTDS INPUTS (OPTION R):

Wire type: 3-wire
Sensor type: 100 Ω platinum (DIN 43760)
 100 Ω nickel, 120 Ω nickel
 10 Ω Copper
 3 mA

RTD sensing current:

Range: -40 to 200° C or -40 to 424° F
Lead resistance: 25 Ω max for Pt and Ni type
 3 Ω max for Cu type
 36 Vpk

Isolation:

BSD INPUTS (OPTION B)

Frequency: 2 – 300 Hz
Dynamic BSD range: 30 mV – 575 V rms

Accuracy:

±0.02 Hz

DIGITAL / SWITCH INPUTS

Inputs: 6 optically isolated
Input type: Dry contact (<800 Ω)
Function: Programmable

CT INPUTS

PHASE CT BURDEN

PHASE CT	INPUT		BURDEN	
	(A)	VA	(W)	
1A	1	0.03	0.03	
	5	0.64	0.03	
	20	11.7	0.03	
5A	5	0.07	0.003	
	25	1.71	0.003	
	100	31	0.003	

GROUND CT BURDEN

GROUND CT	INPUT		BURDEN	
	(A)	VA	(Ω)	
1 A	1	0.04	0.036	
	5	0.78	0.031	
	20	6.79	0.017	
5 A	5	0.07	0.003	
	25	1.72	0.003	
	100	25	0.003	
50:0.025	0.025	0.24	384	
	0.1	2.61	261	
	0.5	37.5	150	

GROUND/PHASE CT CURRENT WITHSTAND

CT	WITHSTAND TIME		
	1 s	2 s	continuous
1 A	100 x CT	40 x CT	3 x CT
5 A	100 x CT	40 x CT	3 x CT
50:0.025	10 A	5 A	150 mA

COMMUNICATIONS

RS232: Front port (up to 19,200 bps, Modbus® RTU)

RS485: 3 rear ports (up to 19,200 bps, 3 V isolation, Modbus® RTU)

Fiber Optic: Option F rear port (up to 19.2 kbps, Modbus® RTU)

Profibus: Option P rear port (up to 12 Mbps, Profibus DP and Profibus DPV1)

Ethernet: Modbus TCP/IP 10base

DeviceNet: Option D rear port (up to 500 kbps)

POWER SUPPLY

CONTROL POWER

Input: LO: 20 – 60 VDC
 20 – 48 VAC; 50 / 60 Hz
 HI: 50 – 300 VDC
 40 – 265 VAC; 50 / 60 Hz

Power: Nominal: 20 VA
 Maximum: 65 VA

Holdup: Non-failsafe trip: 200 ms
 Failsafe trip: 100 ms

OUTPUTS

ANALOG OUTPUT (OPTION M)

OUTPUT	PROGRAMMABLE	
	0 – 1 mA	0 – 20 mA / 4 – 20 mA
MAX LOAD	2400 W	600 W / 600 W
MAX OUTPUT	1.01 mA	20.2 mA / 20.2 mA

Accuracy: ±1% of full scale
 Isolation: 50 V isolated active source

OUTPUT RELAYS

Rated Load	RESISTIVE LOAD (PF = 1)	INDUCTIVE LOAD (PF = 0.4)(L/R – 7ms)
		8 A @ 250 VAC
Carry Current	8 A	
Max Switching Capacity	2000 VA	875 VA
	240 W	170 W
Max Switching V	380 VAC / 125 VDC	
Max Switching I	8 A	
Operate Time	< 10ms (5ms typical)	
Contact Material	Silver alloy	

TYPE TESTS

Dielectric: 2.0 kV for 1 min to relays, CTs, IEC255-5 500 VDC

Insulation: ANSI C37.90.1 oscillatory 2.5 kV/1 MHz

Transients: ANSI C37.90.1 fast rise 5 kV/10 ns

Ontario Hydro A-28M-82

IEC/EN 61000-4.4 Level 4, Frequency disturbance Class III Level

IEC60255-5

Impulse test: 50 MHz/15 W transmitter

RFI: C37.90.2 electromagnetic interference @ 150 MHz and 450 MHz, 10 V/m

EMI: IEC60255-22-2 Level 2

Static: IEC60068-2-38 Part 2, IEC60255-6

Environment: IP50

Dust/moisture: IP50

ENVIRONMENTAL

Operating Temperatures: Cold: IEC60068-2-1, 16hrs at -40°C

Dry Heat: IEC60068-2-2, 16hrs at +85°C

Humidity (non-condensing): IEC60068-2-30, 95%, variant 1, 6 days

Note: LCD contrast impaired below -20° C

PACKAGING

Shipping Box: 12" x 12" x 8" (L x H x D)

305 mm x 305 mm x 203 mm (L x H x D)

Ship Weight: 10 lbs / 4.5 kg

APPROVALS:

ISO: Manufactured under an ISO9001 registered system

UL: Recognized under E234799

UL Class 1 Div 2 (Option Mod502)

CSA: C22.2 no.142, C22.2 no.213

CE: EN 55011/CISPR11, EN50082-2, IEC947-1, IEC1010-1

*Specifications subject to change without notice.

DeviceNet CONFORMANCE TESTED™



Typical Wiring

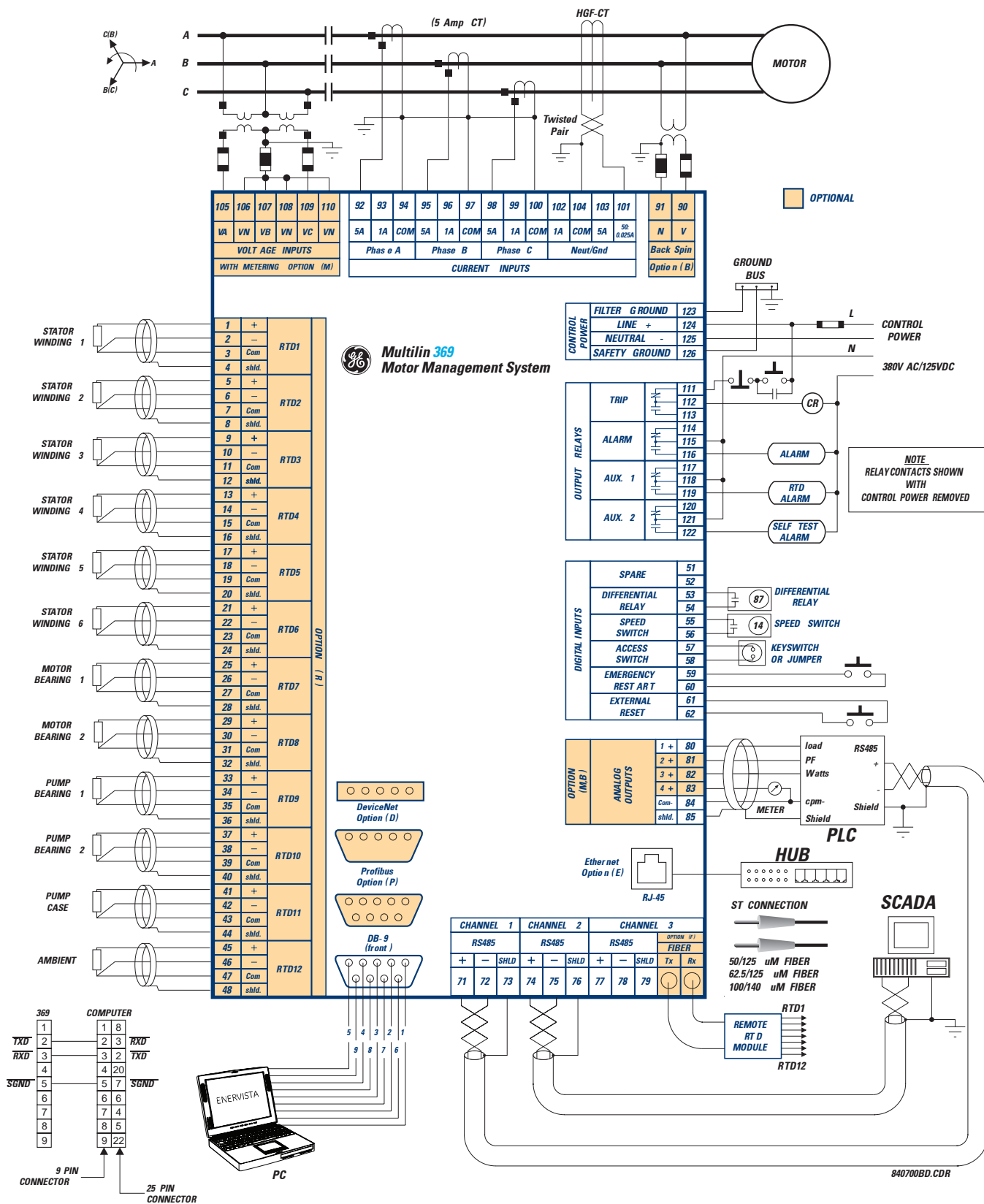

Motor Protection

Ordering

369	*	*	*	*	*	*	
369							Basic unit (no RTD)
	HI						50 – 300 VDC / 40 – 265 VAC Control Power
	LO						20 – 60 VDC / 20 – 48 VAC Control Power
		R					Optional 12 RTD inputs (built-in)
		0					No optional RTD inputs
			M				Optional metering package
			B				Optional backspin detection (includes metering)
			0				No optional metering package or backspin detection
				F			Optional fiber optic port
				0			No optional fiber optic port
					P		Optional Profibus DP0 Interface
					P1		Optional Profibus DPV1 Interface
					E		Optional Modbus® TCP over Ethernet interface
					D		Optional DeviceNet protocol
					0		No optional protocol interfaces
						H	Harsh Chemical Environment Option
						E	Enhanced diagnostics (includes enhanced motor diagnostics, enhanced event recorder, security audit trail) and enhanced faceplate
						0	No enhanced diagnostics and basic faceplate

Accessories for the 369:

- 369 Motor Protection Learning CD TRCD-369-C-S-1
- Multilink Ethernet Switch ML2400-F-HI-HI-A2-A2-A6-G1
- Remote RTD Module RRTD
- Viewpoint Maintenance VPM-1
- Viewpoint Monitoring VP-1

Visit www.GEMultilin.com/369 to:



- View Guideform Specifications
- Download the instruction manual
- Review applications notes and support documents
- Buy a 369 online